

bluewater[®]
 manufacturing corporation

INSTALLATION INSTRUCTIONS

Thermostatic Mixing Valve

3/4" Valve with Dual Exits

Part # 88.30.071

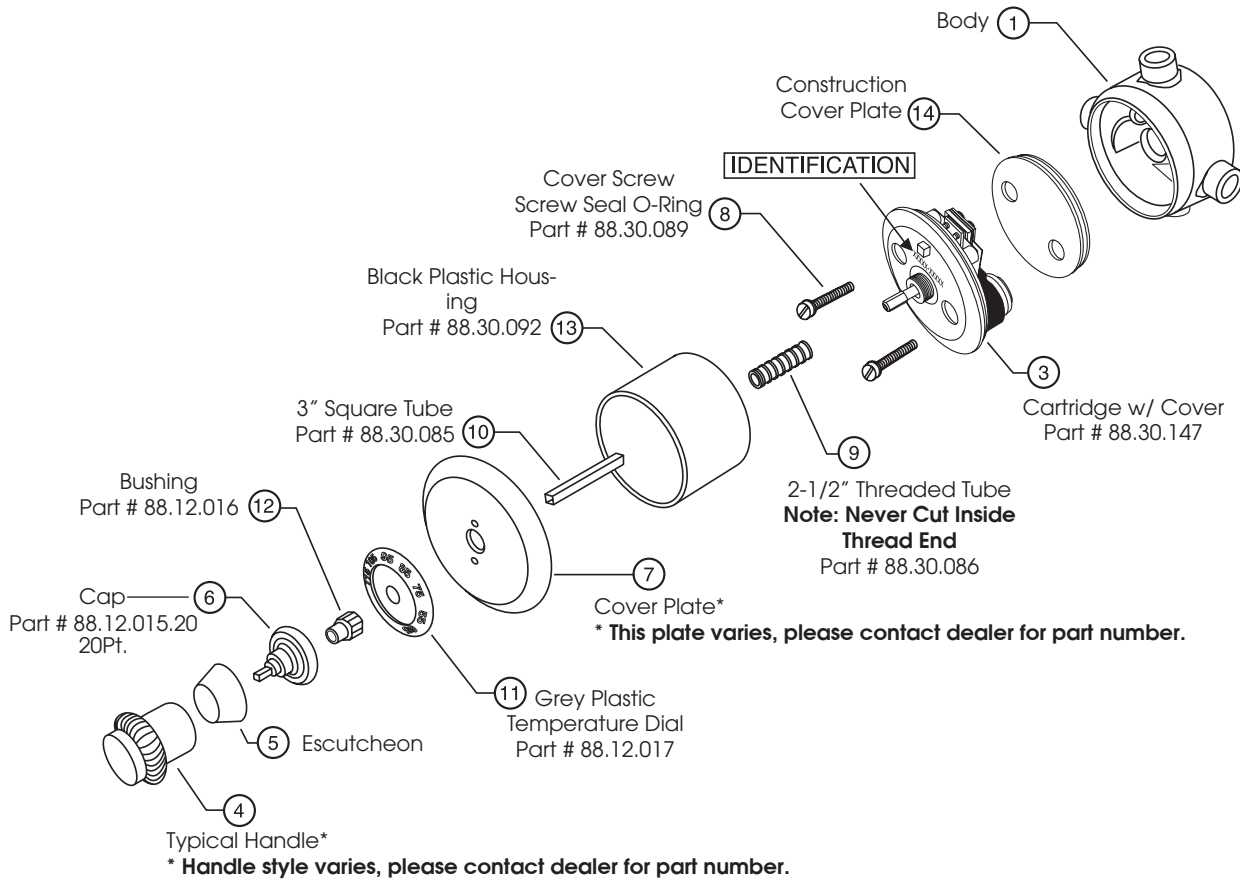

**The 3/4" Rough Valve is Dual Exit Ready
 Use 3/4" Copper Pipe Only**

Extended

4-1/2" Threaded Tube Part #88.30.087
 5" Square Tube Part #88.30.088

Other Parts

3/4" Reverse Cartridge Part #88.30.084
 Cover Seal O-Ring Only Part #88.30.091

Installation

Please Note: The first step in installation, removal of the cartridge, has already been done at the factory. The cartridge has been packaged separately from the valve body to prevent clogging the cartridge during installation. Install the cartridge only when the hot and cold water lines are flushed and fully operational. The water heater must be working or the unit will not work.

We recommend the installation of in-line plumber supplied shut-off valves close to the hot and cold inlets. Please remember the cartridge should be removed and cleaned annually for optimum useful life of the system.

Installation Instructions For 3/4" Valves

Connections

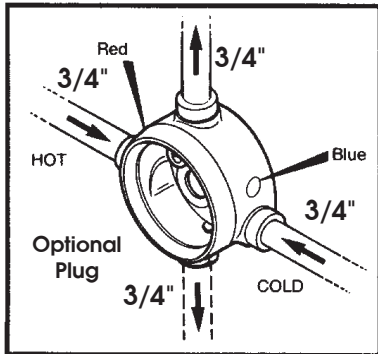

-Important-

Connect the hot water to the side with the red mark and the cold water to the side with the blue mark.

The black housing should act as a depth guide for the plumber. Install the valve so the housing extends beyond the finish wall 1/2".

Cut the plastic housing flush with the FINISH wall. The black housing is to remain with the valve body always for maintenance reasons.

Valve is shipped with standard extensions.

Flushing Lines

Flush the supply pipes completely and carefully by closing the body with the cover and its screws without the cartridge. **Keep foreign matter OUT of the cartridge. Install cartridge only after hot water heater is working.**

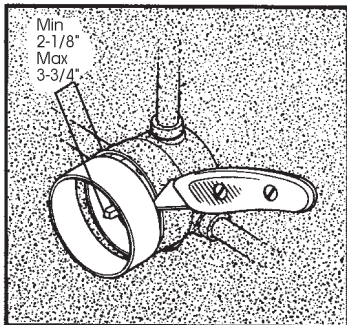

Assembly

Reverse steps performed when removing the cartridge to re-install the cartridge (see p. 3 for diagram). Assemble the cartridge (2), the cover (3) with its screws, fit the threaded tube (9), and screw home. Place the escutcheon (7) and the dial (11) onto the assembly. Make a cutting mark 3/16" from the dial face. Remove the tube, cut it, and debur the cut carefully. Screw the tube home again.

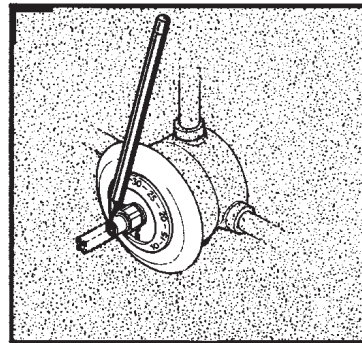
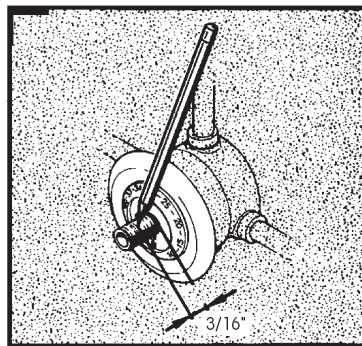

- Screw the bushing onto the threaded tube. Slide the square tube into the bushing and drive it completely into the control spindle.

- Make a cutting mark on the square tube flush with the bushing. Remove the square tube, cut it, and debur carefully. Replace the tube into the bushing and push it all the way into its recess.

Temperature Calibration

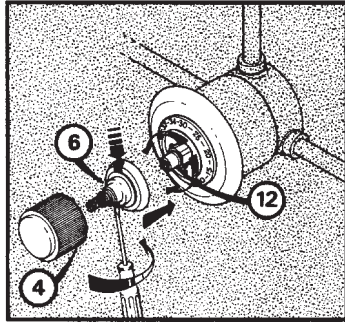

Let the water flow and bring this to a mean temperature by actuating the bushing (12). Note this temperature. Place the cap (6) on the bushing and position the "red" index opposite the graduation corresponding to the temperature noted.

Tighten up the cap setscrew and fit the knob (4) again.

When in use, if a water above 104°F is desired, press the "red" index and turn the knob to the left.

Maintenance

Filter Cleaning

If the cartridge is installed prior to flushing the lines you may inadvertently clog the filters. Dirty filters may lead to a reduction in the flow rate. It is then necessary to clean them with a brush after removing the cartridge (2) from the body of the appliance (see "Cartridge Removal Guide"). Brush the outsides of the filters **ONLY**. **NEVER undo the brass screws, as doing so will VOID THE WARRANTY.**

D. Cleaning the Cartridge

If the cartridge is installed prior to flushing the lines you may inadvertently clog the filters. It will be necessary to remove the cartridge from the mixing valve - never take the cartridge apart or you will void all warranties. Simply soak the entire cartridge in plain vinegar for 1 to 3 hours and reinstall the valve. 90% of the time the valve will then work normally. See Operating Incidents for further details.

Cartridge Removal Guide (Future reference ONLY)

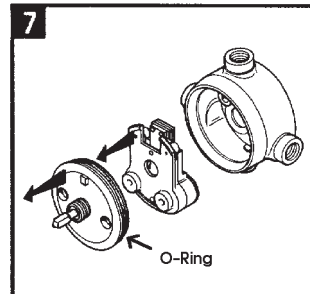
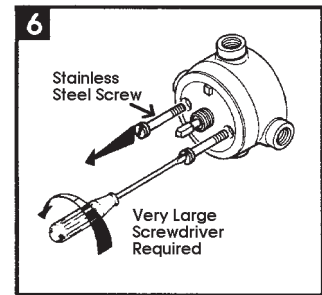
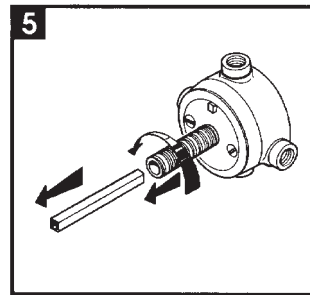
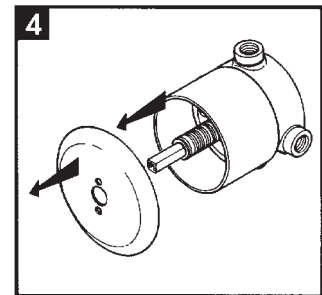
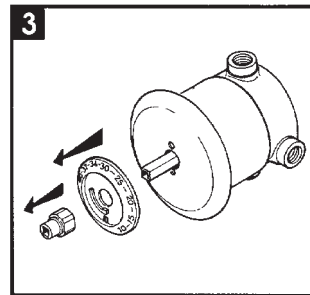
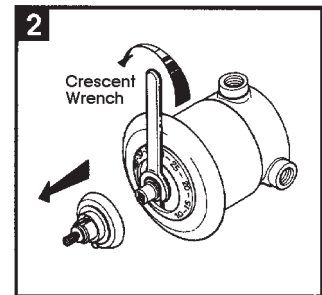
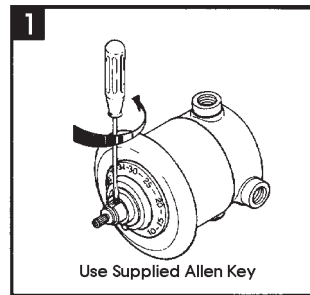

Emptying in case of Frost

When the appliance is exposed to freezing conditions it is **ESSENTIAL** to empty it:

- either by turning on a tap at the bottom outlet
- or by opening the cover (3) of the appliance.

GENERAL THERMOSTATIC INFORMATION FOR HOME OWNER

Please read the complete Thermostatic instructions and cautions contained in this booklet before attempting to install the Thermostatic Valve System.

Please be sure the Homeowner is provided the booklet for future reference for regular maintenance.

FEATURES:

- 1/2" systems come with 1/4 turn ceramic disc cartridges for both the shut-off valves and volume controls. Other sizes may have **optional shut-offs**, ask dealer for details.
- The 1/2" full-flow Thermostatic uses a paraffin wax sensitivity cartridge.
- The 1/2" cartridge constantly monitors temperature and re-adjusts within 2° Fahrenheit of set temperature when supply pressure fluctuates, re-adjustment occurs in less than 2 seconds.
- This thermostatic valve has been in use worldwide for over fifty years.
- Complete serviceability from front of all units.
- Sizes vary from 1/2" - 3/4" - 1", 1-1/4", 1-1/2". and 2" for residential use.
- All other units are Bi-Metal Strip with Built-in Check Valves in the cartridge.
- Extension kits are available through your dealer at an extra charge.
- The Bi-Metallic cartridge delivers the highest flow rate in the industry today.
- The Bi-Metallic cartridge has the fastest response time plus + (or) minus -1 second, and 1° Fahrenheit when fluctuation in supply pressure occurs.
- Keep in mind that the distance the shower head or other exit is from the valve will depend on how fast you feel the instantaneous correction in the temperature.
- Uniform dials and push-button over-rides are interchangeable on all sizes of valves.
- 1/2" and 3/4" size valves come with dual exits as a standard feature. You may decide to plug one exit if you don't need both.

INSTALLATION CAUTIONS!

1. State of the art CNC Machining and 1/4 turn ceramic disc cartridges mean precision made product. **NO HEAT, NO TORCH ...** Shall be applied to the valve assembly.
2. Install adapters at each port, seal the joint, and then run the required copper lengths to the in-coming water. Solder the copper connection a minimum of 8" away from valve body.
3. Use approved thread sealers at all joints. **DO NOT USE PLUMBERS PUTTY, USE OF ANY CAUSTIC MATERIAL MAY HARM THE FINISH AND OR INTERFERE WITH PROPER FUNCTION OF THE CARTRIDGE.**
4. Prior to installing the thermostatic cartridge, flush all water lines to free up all solder, sand, silt, and debris that have loosened up from the installation process. The lines should be flushed long enough to remove any sediment that may come from any new additional installation such as a water heater.
5. Failure to flush all water lines properly may damage internal parts. An In-Line water filter is recommended to remove harmful sediment.
6. Inlet check valves are provided with the 1/2" full-flow system. If factory provided check valves are removed for any reason, a qualified plumbing contractor must install check valves upstream of the valve. All other thermostatic valves that come equipped with the Bi-Metallic strip cartridge have built-in check valves to protect cross-connection.
7. All valves that are not tooled with NPT connectors come with conversion adapters. (Metric and NPT)
8. For proper flow rates and multiple exit installations check with your authorized dealer for installation assistance. When installing body sprays with 1/2" systems (Custom or System 30), no more than three sprays should be plumbed out of the top outlet for maximum flow in conjunction with a pressure balancing loop.
9. Remember water pressure comes from your local water supplier and can be measured at the source on the street.
10. Pressure or water velocity is not a function of the valve.
11. The water meter that is supplied for your home should be 25% larger than the water line supply on your recirculation loop for maximum flow rates from the valve.
12. Do not attempt installation of the product if you do not understand these instructions.
13. **Qualified plumbers should be used for all installation procedures.**

**FAILURE TO FOLLOW INSTRUCTIONS MAY CAUSE DAMAGE
OR IMPROPER OPERATION AND VOID THE WARRANTY.**

1. Flush all rough-in piping thoroughly to remove sediment, flux and other debris.
2. Hot and cold inlets are clearly marked. **DO NOT REVERSE CONNECTIONS, THE UNIT WILL NOT WORK CORRECTLY.**
3. **DO NOT USE DIRECT HEAT, OR ANY TORCH ON 1/2" ROUGH VALVES.**
4. If unit comes with a black or gray plastic outer ring -- read directions and be sure you keep above ring installed even after the trim is installed.
5. Minimum and maximum finished wall tolerances are clearly marked.
(SEE EXPLODED VIEW OF VALVE)
6. It is extremely important that the rough mixing chamber be free of all debris before installation of the thermostatic cartridge. Read all instructions on boxes, valves and cartridges.
7. Under no circumstances should the thermostat cartridge be dismantled. Doing so will void any warranty and generally make the cartridge inoperable.

MAINTENANCE

The Bi-Metallic strip cartridge has two filter screens and a simple cleaning with a toothbrush will remove surface debris.

Soaking the cartridge in a 50/50 solution of clear household vinegar and water will remove lime scale, and lime deposits caused from your water.

Regular cleaning each year will extend the life of the cartridge. Never use a screwdriver on any thermostatic cartridge. **Never take a thermostatic cartridge apart as you will damage this precise instrument.** Call your dealer or the factory for answers to your questions.

Technical Information

The thermostatic valve is designed to operate at water pressures as low as 14 psi and as high as 140 psi. If you have lower or higher pressure please consult the factory representative for suggestions or solutions.

1/2", 3/4", and 1" units are most commonly used for the deluxe shower, suite, or residential bath. Two or three bath components are often combined (i.e. hall bath, kids' bath, and guest all combined). These units all use the same size decorative wall plate & are available in any of our handle and finish trims. For more details contact your sales representative.

1-1/4", 1-1/2", and 2" units do not come with decorative trim, as these valves are very large and require easy access to install and use. Call for further details.

Important: All main lines must be the same size or larger than the supplied valve or the flow rates will not work. Therefore, if you use a 1-1/4" valve your water system should be based on a minimum 1-1/4" line--absolutely no smaller restriction should be allowed.

Water Supply

The thermostatic valve can be supplied from any hot water production system, even by instantaneous domestic production, as far as the generator is capable of supplying very small quantities of hot water (about 0.8 gal/min).

- Maximum working pressure	145 PSI
- Minimum working pressure	14 PSI
- Recommended working pressure	29 to 58 PSI
- Maximum test pressure	224 PSI
- Maximum hot water temperature	185°F

Options

'Reverse' cartridges are available to correct improper installation (this special order is an extra charge and takes 12 weeks for delivery).

Shut-Off Valves

The mixer itself determines the proportions of hot and cold water required for the mixture. **The mixer however regulates the temperature only and not the output; one shut-off valve (or more) must therefore be provided at the outlet(s) to control water flow.**

Non-Return Valves and Filters

Non-return valves are incorporated into the cartridge. This valve incorporates easily accessible stainless steel filters at the inlets of the cartridge. However, in order to access the cartridge, we recommend the installation of in-line plumber supplied shut-off valves close to the hot and cold inlets. Please remember the cartridge should be removed and cleaned annually for optimum useful life of the system.

**STANDARD
THERMOSTATIC VALVE**

-FULL SCALE (1:1) CUTOUT TEMPLATE-

COVER PLATE

06.250 WALL CUTOUT
(SEE NOTE 2)

PLATE
(SEE NOTE 1)

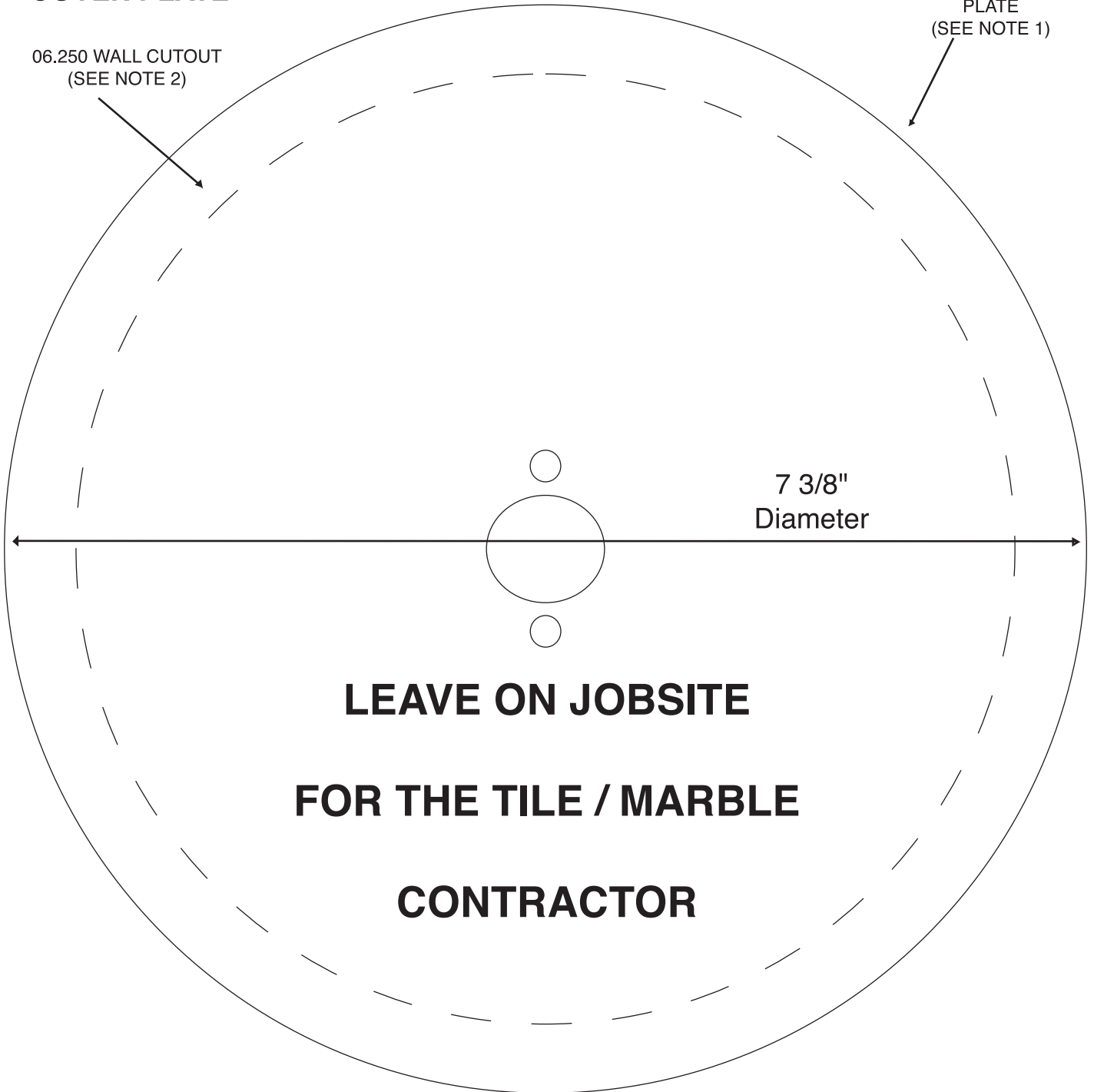

NOTES:

1. SOLID LINE REPRESENTS THE ACTUAL OUTLINE OF THE TRIM PLATE.
2. DASHED LINE REPRESENTS THE TYPICAL WALL CUTOUT FOR STANDARD THERMOSTATIC VALVE INSTALLATION FOR 3/4" AND 1" SIZE VALVES.

**OPERATING SOLUTION FOR THERMOSTATIC MIXERS
USING 3/4", 1", 1-1/4", 1-1/2", AND 2" BI-METAL CARTRIDGES**

In the event of an operating problem with a thermostatic mixer, review the following information. Make sure hot and cold inlets are correctly connected to the marked hot and cold side of the mixer. Be sure there is sufficient water pressure and that you have calibrated the mixer valve correctly. Check whether the screens are clean of debris. The main operating problems, their causes and remedies are described below. If the problem is caused by the mixer, return the replaceable mechanism or the complete mixer (industrial models) to the factory.

OPERATING DEFECTS	REASON	REMEDIES
1 - When first using a new appliance, only hot or cold water is delivered.	- The water inlets are reversed. - The bimetal strip is not properly centered. - The distributing valve is not free.	1 5 7
2 - The mixed water temperature follows the position of the graduated regulator but with a certain delay.	- The control system is incorrectly calibrated.	2 6
3 - The appliance does not deliver mixed water or only when the regulator is turned up all the way.	- One of the water inlets doesn't work.	3
4 - The mixed water is delivered in spurts and the flow rate is low except at one temperature or the limited temperatures.	- One of the water supplies doesn't provide sufficient water.	4
5 - From time to time the appliance only delivers hot or cold water.	The bimetal strip is not properly centered. - The distributing valve is not free.	5 7 8
6 - The water is always supplied at the same temperature hot or cold.	- The bimetal strip does not move the distributing valve: a) Because the distributing valve is not free. b) Because the regulating screw does not act on the mechanism.	7 10 8
7 - The temperature is irregular, especially when flow rates are low.	- There are foreign particles beneath the membrane. - The membrane is damaged.	8
8 - Insufficient mixed water is supplied.	- Pressure is too low. - One of the water supplies is insufficient.	3 9
9 - The different water supplies intercommunicate in the mixer.		6

VALVE CARE

Your 1/4 turn ceramic valve will provide you a lifetime of service when cared for properly. The most common valve problem is a result of debris in the water line, such as sand, silt, solder, metal shavings, lime deposits or other foreign particles. Debris can become lodged between the ceramic discs and result in improper functioning of the open and close action of the valve. Particles can even cause cracks in the ceramic discs and render the cartridge useless. For further information, please contact Bluewater Manufacturing Corporation @ 877-890-8006 or fax your request to 877-373-0649

**BLUE WATER MANUFACTURING CORPORATION
LIMITED PRODUCT WARRANTY**

Product/Finish Warranty: Bluewater Manufacturing Corporation warrants that products are free from manufacturing defects in materials and workmanship for five (5) years from date of invoice. In addition, our Finish Warranty provides limited LIFETIME coverage for Chrome & PVD finishes, five (5) years for powder coated finishes & Polished Gold. Living finishes are warranted for workmanship only. If any material proves to be defective after inspection by our company, it will be repaired or replaced at our discretion at no charge. However, no claims for labor, shipping costs, or consequential damages will be accepted.

What we will do: We will restore any product whose finish proves to be defective back to its original finish at no charge during the appropriate warranty period stated above. Proof of purchase must be provided. After the warranty period, **Bluewater Manufacturing Corporation** will refinish any of its faucets at the prevailing appropriate charge.

What you must do: The faucets must be properly installed according to our instructions and specifications and are for residential use only. The faucets cannot be altered in any way. You must maintain and clean the faucets in accordance with the instructions provided with the product. You must use the faucet(s) for residential use only.

How to obtain service: Send your name, address, and telephone number along with a statement describing the nature of the problem and your paid sales slip or other proof of purchase to:

**BLUE WATER MANUFACTURING CORPORATION
3231-C Business Park Drive #31
Vista, CA 92081**

We will then contact you and take appropriate action. Do not send us any part(s) of your faucet(s) or its various connecting hoses unless we have contacted you and have sent you an approved RGA form. All transportation charges for returned goods must be paid by the customer.

What is not covered: This warranty does not cover the crystal/glass, or porcelain products of any faucet or the drain assembly or aerator on other than the Chrome or PVD finishes. This warranty also does not cover damage caused by accident, alterations, misuse, abuse, normal wear and tear, lime deposits, direct exposure to salty air or corrosive materials, or the color change that takes place with the passage of time, or use in any manner contrary to **Bluewater Manufacturing Corporation's** printed instructions. Cartridge warranties vary. Please call factory for details. In the case of in-the-wall installations, **Bluewater Manufacturing Corporation** will assume no liability if there is no access. **In no event will we be liable for labor of any kind, incidental or consequential damages.** This warranty is extended in lieu of all other expressed or implied warranties, whether oral or written. **Many installation compounds are harmful to brass and metal finishes. The use of any lead-based or acidic curing adhesive, silicone, mastic, or plumber's putty on or near our finished products will void the finish warranty. Use only sealants which are neutral curing and are not reactive with metal and brass finishes.** **Bluewater Manufacturing Corporation** reserves the right to change, modify or alter its products as deemed necessary. This warranty supersedes any other American Faucet & Coatings Corporation warranties, whether oral or written.

Unless otherwise contrary to state law governing the purchase, Bluewater Manufacturing Corporation's liability will not exceed the wholesale price for the Bluewater Manufacturing Corporation product considered defective. This warranty gives you specific legal rights, and you may also have other rights which vary from state to state. Some states do not allow exclusion of incidental or consequential damages, so the above limitation may not apply to you.

LIFETIME WARRANTY ON 1/4 TURN CERAMIC DISC CARTRIDGE

Should the ceramic disc cartridge in your faucet ever fail, **Bluewater Manufacturing Corporation** will replace the failed part free of charge to the original purchaser of the product. Your cost will be a \$7.95 handling and mailing charge. Labor not included. When ordering replacements, denote for widespread or centerset lavatory, Roman Tub, or other. Include age of faucet. (This does not include thermostatic, pressure balance, or diverter cartridges.)

NOTICE

Bluewater Manufacturing Corporation products are IAPMO listed and are tested to ASME A112.18.1M and ASSE 1016, and comply with Section 9 of NSF 61 for basin faucet, bar faucets, and kitchen faucets as required.