



WELCOME TO "MODERN SERIES" PRICELIST

Our "Modern Series" Include: Anzio, Milano, Siena & Torino

for our entire pricelist of all Bluewater products
please download it from on our home page or use this link:
<http://www.bluewaterfaucet.com/BluewaterPricelist07-25-08.pdf>

**The following page numbers refer to the page numbers listed in the bottom corners of this .pdf,
not the pages of the .pdf document itself.**

<u>SERIES</u>	<u>PAGE</u>
Series Index and Handles	67
How to Order (guides you through our ordering system for each series)	68
Anzio	69
Milano	70
Siena	71
Torino	72

If you need any help or have any questions feel free to contact us.

Nanci Powell - Customer Service Manager

Tel: 888-267-8759

Fax: 856-384-5965

Email: Info@TectonicEnterprises.com

Modern Series Index

	<i>Page</i>
<i>Anzio</i>	69
<i>Milano</i>	70
<i>Siena</i>	71
<i>Torino</i>	72



701



702



703

Available Finishes for Modern Series

Selected Finishes have been made in order to expedite these products. Allow a 10 to 14 day lead time for these products. Please contact our factory for a wider selection of finishes. See pages V, VI, and VII.

Group I

Polished Chrome (26)
Satin Nickel Coated (69)
Oil Rubbed Bronze (80)

Group II

Soft Pewter (84)
Polished Brass PVD (40)
Polished Nickel PVD (43)
Satin Nickel PVD (42)

Group III

Bluewater Antique Bronze (34)
Bluewater Antique Bronze Distressed (34D)
Soft Pewter Distressed (84D)
Oil Rubbed Bronze Distressed (80D)

How to Order

Modern Series

Example Part

"Siena" Roman Tub Set with Contemporary Handshower Cross Handle in Soft Pewter Distressed (Refer to Page 71)

43.702.15.84D

STEP 1 (Spout)	STEP 2 (Handles)	STEP 3 (Function)	STEP 4 (Finish)
43.	702.	15.	84D

STEP 1 - SPOUT STYLE
48 Anzio
43 Milano
45 Siena
28 Torino
00 No Specific Style

STEP 2 - HANDLES
Handles
Refer to
Page 67

STEP 3 - FUNCTION
10 Widespread Lav
13 Wall Lav
14 Roman Tub Set
14T Roman Tub Trim only
15 Roman Tub w/Handshower
15T Roman Tub w/Handshower Trim only
23 Bidet
00 Vessel Lav Faucet

STEP 4 - FINISH
26 Polished Chrome
69 Satin Nickel Coated
80 Oil Rubbed Bronze
84 Soft Pewter
40 Polished Brass PVD
43 Polished Nickel PVD
42 Satin Nickel PVD
34 Antique Bronze
84D Soft Pewter Distressed
34D Antique Bronze Distressed
80D Oil Rubbed Bronze Distressed

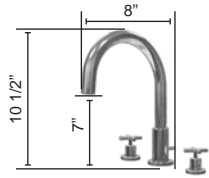

Anzio Widespread Lav 48.____.10 *Group I: \$699* *Group II: \$809* *Group III: \$1029*
Center to Center 6 1/2"

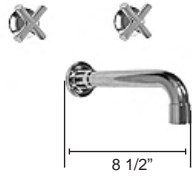

Anzio Wall Mount Lav Set with Grid Drain **Complete** 48.____.13 *Group I: \$699* *Group II: \$809* *Group III: \$1029*

Anzio Wall Mount Lav Set with Grid Drain **Trim Only** 48.____.13T *Group I: \$460* *Group II: \$570* *Group III: \$790*

Corner Valves R30.013 **\$239**



3 Hole Bidet Set **Complete** 00.____.23 *Group I: \$819* *Group II: \$919* *Group III: \$1019*

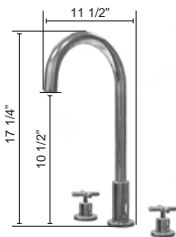

CENTER TO CENTER 10 1/2"

Anzio Deluxe 17" Roman Tub Set **Complete** 48.____.14 *Group I: \$919* *Group II: \$1029* *Group III: \$1249*

Anzio Deluxe 17" Roman Tub Set **Trim Only** 48.____.14T *Group I: \$620* *Group II: \$730* *Group III: \$950*

(1) Pair 3/4" Rough Valves R30.014 **\$299**



CENTER TO CENTER 10 1/2"

Anzio Deluxe 17" Roman Tub Set with Contemporary Handshower **Complete** 48.____.15 *Group I: \$1439* *Group II: \$1549* *Group III: \$1939*

Anzio Deluxe 17" Roman Tub Set with Contemporary Handshower **Trim Only** 48.____.15T *Group I: \$970* *Group II: \$1080* *Group III: \$1470*

(1) Pair 3/4" Rough Valves with Deck Diverter Valve R30.030 **\$469**



Thermostatic Shower Set **Complete** with 7 1/4" Plate 00ET.____.76 *Group I: \$1019* *Group II: \$1129* *Group III: \$1239*



Thermostatic Shower Set **Trim Only** 00ET.____.76T *Group I: \$480* *Group II: \$590* *Group III: \$700*

1/2" Forged Valve with TSV Cartridge R30.076 **\$539**



Thermostatic Tub and Shower **Complete** with 7 1/4" Plate 48ET.____.77 *Group I: \$1289* *Group II: \$1399* *Group III: \$1509*



Thermostatic Tub and Shower Set **Trim Only** 48ET.____.77T *Group I: \$680* *Group II: \$790* *Group III: \$900*



1/2" Forged Valve with TSV Cartridge R30.077 **\$609**

All Handle Selections with New Euro Connections



701



702
20 Point



703

Milano

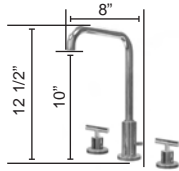

Milano
Widespread Lav
Center to Center 6"

43.____.10

Group I: **\$659**

Group II: **\$769**

Group III: **\$989**

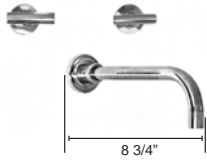

Milano/Siena
Wall Mount Basin Set with
Grid Drain **Complete**

43.____.13

Group I: **\$659**

Group II: **\$769**

Group III: **\$989**

Milano/Siena
Wall Mount Basin Set with
Grid Drain **Trim Only**

43.____.13T

Group I: **\$420**

Group II: **\$530**

Group III: **\$750**

Corner Valves

R30.013

\$239



3 Hole Bidet Set
Complete

00.____.23

Group I: **\$819**

Group II: **\$919**

Group III: **\$1019**

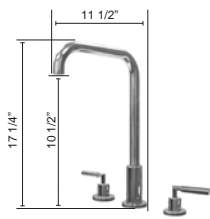

Milano Roman Tub Set
Complete

43.____.14

Group I: **\$879**

Group II: **\$979**

Group III: **\$1209**

Milano Roman Tub Set
Trim Only

43.____.14T

Group I: **\$580**

Group II: **\$680**

Group III: **\$910**

(1) Pair 3/4"
Rough Valves

R30.014

\$299

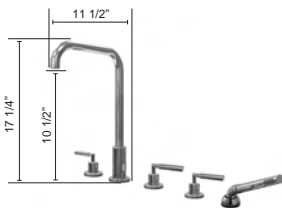

Milano Roman Tub Set
with Contemporary
Handshower **Complete**

43.____.15

Group I: **\$1399**

Group II: **\$1509**

Group III: **\$1729**

Milano Roman Tub Set with
Contemporary Handshower
Trim Only

43.____.15T

Group I: **\$930**

Group II: **\$1040**

Group III: **\$1260**

(1) Pair 3/4" Rough
Valves with Deck
Diverter Valve

R30.030

\$469



Thermostatic Shower
Set **Complete** with
7 1/4" Plate

00ET.____.76

Group I: **\$1019**

Group II: **\$1129**

Group III: **\$1239**



Thermostatic Shower
Set **Trim Only**

00ET.____.76T

Group I: **\$480**

Group II: **\$590**

Group III: **\$700**

1/2" Forged Valve with
TSV Cartridge

R30.076

\$539



Thermostatic Tub and
Shower **Complete** with
7 1/4" Plate

43ET.____.77

Group I: **\$1289**

Group II: **\$1399**

Group III: **\$1509**



Thermostatic Tub and
Shower Set **Trim Only**

43ET.____.77T

Group I: **\$680**

Group II: **\$790**

Group III: **\$900**



1/2" Forged Valve with
TSV Cartridge

R30.077

\$609

All Handle Selections with New Euro Connections



701



702
20 Point



703



Siena Widespread Lav 45.____.10 *Group I: \$619* *Group II: \$729* *Group III: \$819*
Center to Center 6 1/2"



Siena/Milano Wall Mount Basin Set with Grid Drain **Complete** 43.____.13 *Group I: \$619* *Group II: \$729* *Group III: \$819*

Siena/Milano Wall Mount Basin Set with Grid Drain **Trim Only** 43.____.13T *Group I: \$380* *Group II: \$490* *Group III: \$580*

Corner Valves R30.013 **\$239**



3 Hole Bidet Set **Complete** 00.____.23 *Group I: \$819* *Group II: \$919* *Group III: \$1019*

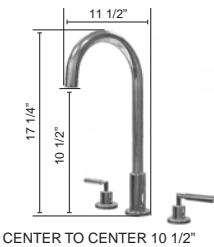

Siena Deluxe 17" Roman Tub Set **Complete** 45.____.14 *Group I: \$799* *Group II: \$919* *Group III: \$1059*

Siena Deluxe 17" Roman Tub Set **Trim Only** 45.____.14T *Group I: \$500* *Group II: \$620* *Group III: \$760*

(1) Pair 3/4" Rough Valves R30.014 **\$299**



Siena Deluxe 17" Roman Tub Set with Contemporary Handshower **Complete** 45.____.15 *Group I: \$1319* *Group II: \$1539* *Group III: \$1459*

Siena Deluxe 17" Roman Tub Set with Contemporary Handshower **Trim Only** 45.____.15T *Group I: \$850* *Group II: \$1070* *Group III: \$990*

(1) Pair 3/4" Rough Valves with Deck Diverter Valve R30.030 **\$469**



Thermostatic Shower Set **Complete** with 7 1/4" Plate 00ET.____.76 *Group I: \$1019* *Group II: \$1129* *Group III: \$1239*



Thermostatic Shower Set **Trim Only** 00ET.____.76T *Group I: \$480* *Group II: \$590* *Group III: \$700*

1/2" Forged Valve with TSV Cartridge R30.076 **\$539**



Thermostatic Tub and Shower **Complete** with 7 1/4" Plate 45.____.77 *Group I: \$1289* *Group II: \$1399* *Group III: \$1509*



Thermostatic Tub and Shower Set **Trim Only** 45.____.77T *Group I: \$680* *Group II: \$790* *Group III: \$900*



1/2" Forged Valve with TSV Cartridge R30.077 **\$609**

All Handle Selections with New Euro Connections



701



702



703

20 Point

Torino

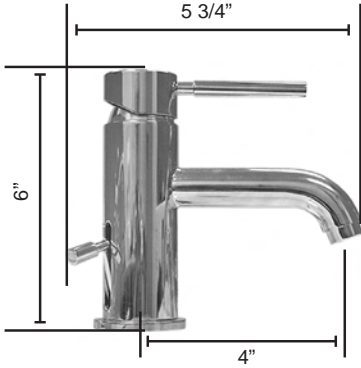

Torino Single Hole
Lav Faucet
with Standard
Pop-Up Drain

28.010.00

Group I: **\$439**

Group II: **\$549**

Group III: **\$659**

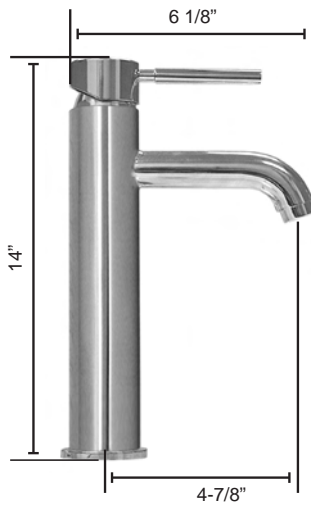

Torino Vessel
Lav Faucet
with Standard
Pop-Up Drain

28.011.00

Group I: **\$549**

Group II: **\$659**

Group III: **\$769**